

Installation and Operating

BU 190(t) S 48

Movement for DCF / MSF time code

Please read this instructions carefully before installation.



Content

1. Dimensions, Definitions	3
2. Function description	4
3. Mounting guidelines	4
3.1 Mounting of movement series BU 190(t) S	4
3.2 Mounting of hands and Starting-up	4
3.2.1 Mounting of hands	4
3.2.2 Starting-up and check of the hand position	5
4. Setting up / Connections	5
4.1 Synchronization with DCF or MSF time code.....	5
4.2 Connection / cascading	6
5. Technical specification	7

References to the User's Manual

1. The information in this User's Manual can be changed at any time without previous notice. The current version is available for download on www.mobatime.com – Downloads.
2. This User's Manual has been composed with utmost care, in order to explain all details in respect of the operation of the product. Should you, nevertheless, have questions or discover errors in this Manual, please contact us.
3. We do not answer for direct or indirect damages, which could occur, when using this Manual.
4. Please read the instructions carefully and start the setting-up of the product, only once you have correctly understood all information for the installation and of the operation.
5. The installation must only be carried out by skilled staff.
6. It is prohibited to reproduce, to store in a computer system or to transfer this publication in a way or another, even part of it. The copyright remains with all the rights with MOSER-BAER AG, CH-3454 Sumiswald / Switzerland.

1. Dimensions, Definitions

Diameter	Type	Art.-No.
30 - 80 cm	Movement: BU 190 S 48	200842
30 - 80 cm	Movement: BU 190t S 48	200843

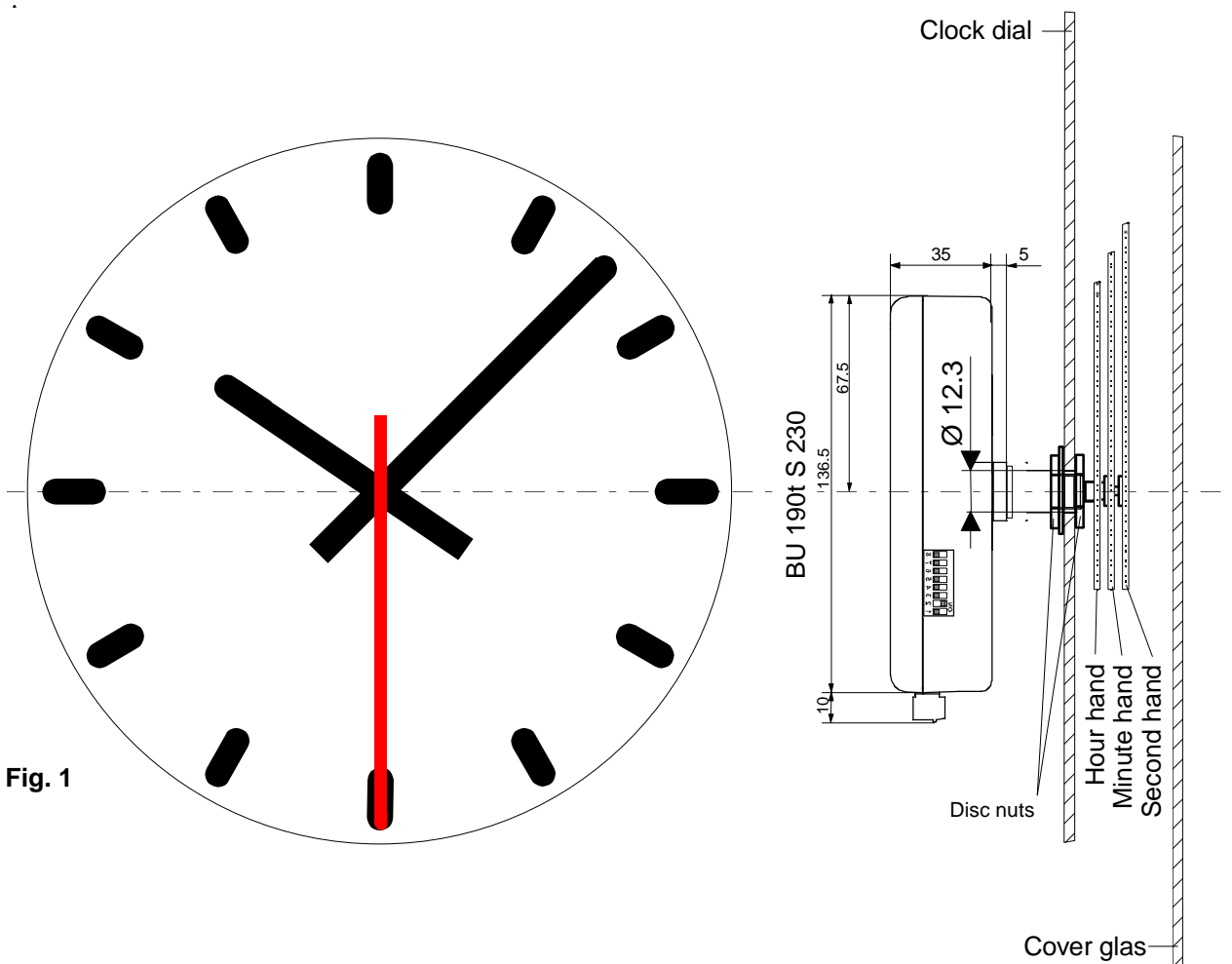

Fig. 1

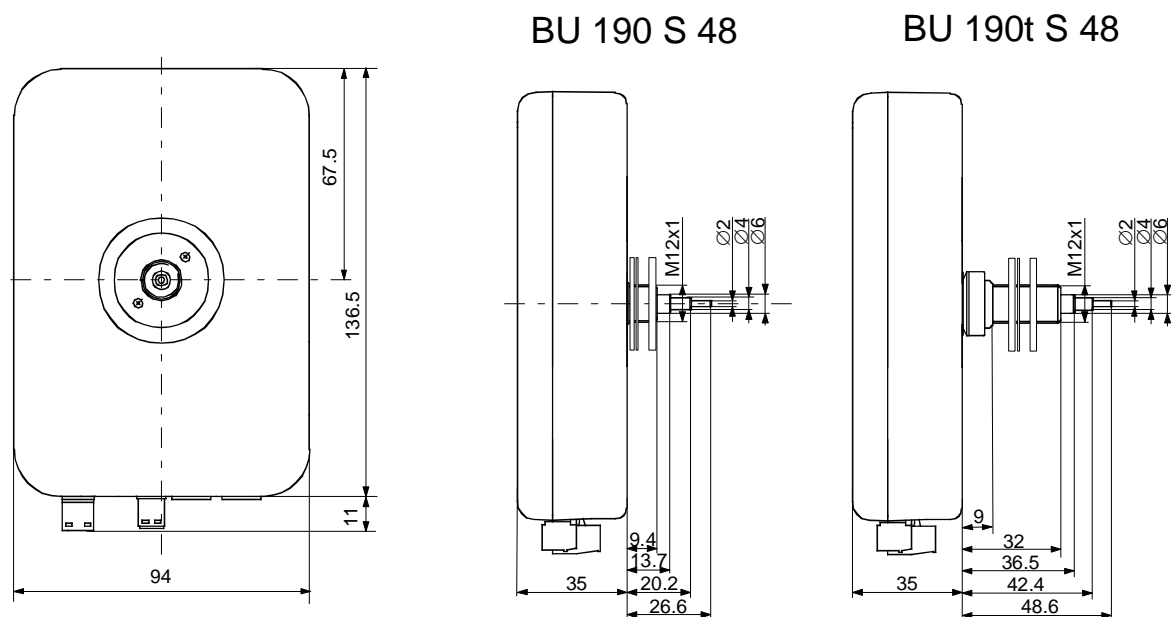

Fig. 2

2. Function description

Self-setting movement with hour, minute and second display. For autonomous self-setting clocks for indoor or outdoor use with dial diameters up to 80 cm, with or without illumination.
Connection compatible to SFA 130 / 140.

- DCF-77 or MSF-60 radio control with automatic time take-over and daylight saving time change-over by means of a connected radio time signal receiver.
- Central-European time zones CET-1, CET and CET+1 selectable by DIP-switch.
- Signalization of missing DCF/MSF time code reception after a period of one week by setting the hands to 12 o'clock position.
- Internal battery-less power reserve for at least 5 minutes operation (not for second hand).
- Internal quartz clock for precise time display even without DCF/MSF radio reception.
- Immediate resetting to the correct time after mains failure of up to 12 hours due to an internal real-time-clock (battery-less powered).
- Radio time signal output for the connection of a further movement. Up to 4 movements can be connected to one radio receiver.
- Different running modes of the second hand, selectable by means of a DIP-switch.
- Possibility of connection of an MSF-60 radio receiver (Rugby) as well.

3. Mounting guidelines

3.1 Mounting of movement series BU 190(t) S

The dial must be sufficiently stable. The fixing hole must have a diameter of 12.3 mm.

The movement must be fixed in vertical position.

Vide Fig. 3 for the position of mounting parts.

The disc nut (2*) M12 x 1 has to be tightened with a special wrench tool (Art. No. 201998) and a torque wrench with a torque of 4.5 Nm +/- 0.2 Nm.

Attention:

The ring nut (5), the compensation ring (6) and the spring washer (7) must not be removed.

After tightening of the disc nut (2*), the movement must not be wrenched!

3.2 Mounting of hands and Starting-up

3.2.1 Mounting of hands

The shafts of the hour, minute and second hands are positioned ex-work on the reference position (12 o'clock). The hands shall be carefully fixed and tightened on the shafts. Enough space must be provided between the hands. See Fig. 4.

The position 12 o'clock must be checked on each movement after the mounting (Chap.3.2.2).

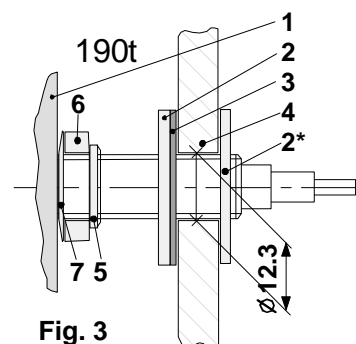

Fig. 3

- 1 Movement
- 2 Disc nut
- 3 Rubber washer
- 4 Dial
- 5 Ring nut
- 6 Compensation ring
- 7 Spring washer

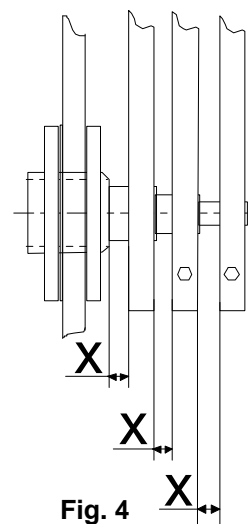

Fig. 4

3.2.2 Starting-up and check of the hand position

- Set DIP switch 1 to **ON** position (12:00 Position, Fig. 5)
- Connect the 48V power supply to the "AC/DC 48V" plug (Fig. 6).
The clock runs to 12 o'clock position.
→ Position of hands OK?
- If the hand position is wrong, carefully loosen the hand, adjust and tighten.
- Reset DIP Switch 1 to **OFF** position
→ Check the 12 o'clock position again (initialising by an interruption of the power supply).
- If hand position OK, continue with chapter 4 for further setting-up.

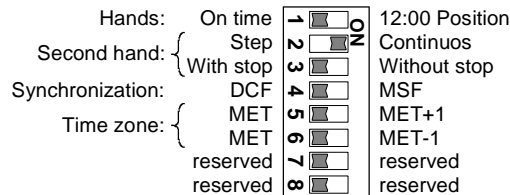

Fig. 5

4. Setting up / Connections

- If the 12 o'clock position of the clock is OK, reset DIP Switch 1 to **OFF** position (Fig. 5).
- The movement can be synchronized with following time codes:
- DCF, MSF (see chapter 4.1)

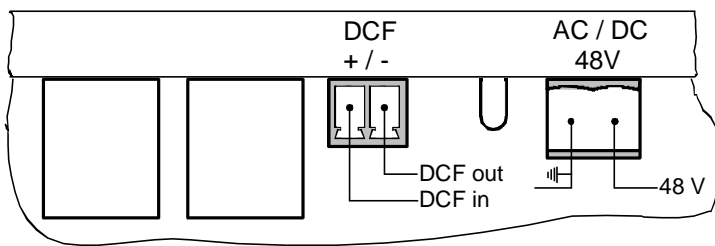

Fig. 6

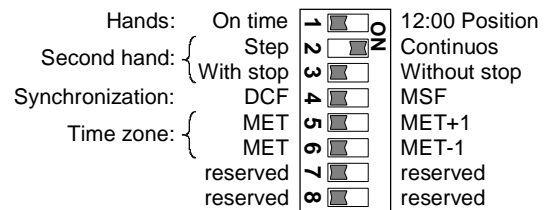

Fig. 7

4.1 Synchronization with DCF or MSF time code

- The Radio time signal receiver (DCF / MSF 450 (4500) must be connected to the terminals "DCF in" and "48V GND" (see Fig. 6, 8, 9).



To ensure the reception quality, the designated pin of "AC / DC 48V" plug has to be connected with earth potential (e.g. clock housing).

- select time codes:
 - For DCF set DIP-switch 4 to OFF position
 - For MSF set DIP-switch 4 to ON position
 - Time: London local time (WET)

- Select time zones:

Depending upon condition DCF can also be received in west Europe

(CET -1) (Greece, Portugal), or in east Europe (CET +1).

- for CET -1 set DIP-switch 6 to ON position
- for CET +1 set DIP-switch 5 to ON position

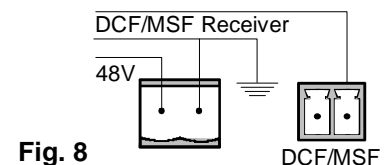

Fig. 8

To ensure the reception quality the designated pin of the "AC / DC 48V" plug has to be connected with the earth potential (functional earth, i.e. clock housing).

- Control of the reception quality:

The orientation of the radio time signal receiver should be chosen in a way, the LED of the receiver flashes regularly (at good reception quality the LED in the receiver flashes regularly in second rhythm), see also the instruction manual of the receiver.

- When reception condition is OK, the movement starts after about 3 minutes and set itself automatically on the exact time.

4.2 Connection / cascading

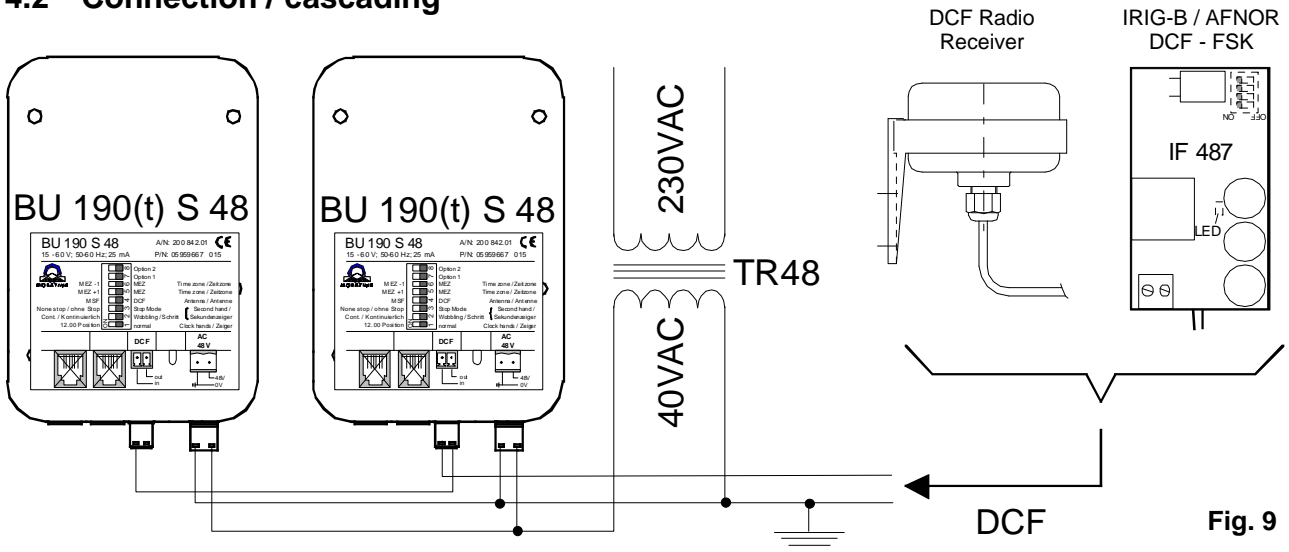

Attention:
Max. 2 movements per transformer TR48.

To ensure the reception quality the designated pin of the "AC / DC 48V" plug has to be connected with the earth potential (functional earth, i.e. clock housing).

Fig. 9

To connect the radio signal to a double sided clock (two movements), the time signal can be wired from "DCF out" terminal of the master movement to the "DCF in" terminal of the slave movement (Fig.9).

5. Technical specification

	BU 190 S 48	BU 190t S 48
Synchronisation	DCF-77: with time signal receiver DCF 450, DCF 4500 MSF-60: with time signal receiver MSF 4500	
Setting times: Running time to reference pos. Read in of time Running time for new adjustment Changes of daylight saving time	6 minutes maximum serial: 3 – 5 seconds / radio signal: 3 – 5 minutes 10 seconds – 6 minutes 5.5 minutes maximum	
Operation mode second shaft	- Continuous or secondly pace shift (wobbling) - 1 revolution in 60 s or 1 revolution in 58 s with stop at 12.00 and start with the minute change	
Operation mode minute shaft	1 step every 60 s	
Operation mode hour shaft	continuous	
Operation voltage	15 – 50 VAC (50 – 60Hz) / 20 – 60 VDC	
Power consumption	< 25 mA	
Stand-by reserve	at least 5 min. (hour / minute) / 0 min. (seconds)	
Time keeping with internal quartz clock	> 12 h	
Number of motors	2 (hour / min. + sec.)	
Dial diameter	25 – 80 cm	
Max. dial thickness	4 mm	14.5 mm
Temperature range	-30 ... +70°C	
Weight	340 g	380 g
Standards	EN 50121-4, EN 61000-6-3	
Safety	EN 60950-1, Protection class II	

Technical data subject to change without notice

www.mobatime.com



SALES SWITZERLAND

MOBATIME AG

Stettbachstrasse 5 • CH-8600 Dübendorf
Tel. +41 44 802 75 75 • Fax +41 44 802 75 65
info-d@mobatime.ch • www.mobatime.ch

MOBATIME SA

En Budron H 20 • CH-1052 Le Mont-sur-Lausanne
Tél. +41 21 654 33 50 • Fax +41 21 654 33 69
info-f@mobatime.ch • www.mobatime.ch

SALES WORLDWIDE

MOSER-BAER SA – EXPORT DIVISION

19 chemin du Champ-des-Filles • CH-1228 Plan-les-Ouates/GE
Tel. +41 22 884 96 11 • Fax. +41 22 884 96 90
export@mobatime.com • www.mobatime.com

PRODUCTION

MOSER-BAER AG

Spitalstrasse 7 • CH-3454 Sumiswald
Tel. +41 34 432 46 46 • Fax. +41 34 432 46 99
moserbaer@mobatime.com • www.mobatime.com

SALES GERMANY, AUSTRIA

BÜRK MOBATIME GmbH

Postfach 3760 D-78026 VS-Schwenningen
Steinkirchring 46 D-78056 VS-Schwenningen
Telefon +49 7720 8535 - 0 Telefax +49 7720 8535 - 11
Internet: <http://www.buerk-mobatime.de> E-Mail: buerk@buerk-mobatime.de